



PUNJAB STATE POWER CORPORATION LIMITED

(Regd. Office : PSEB Head Office, The Mall, Patiala - 147001)
Corporate Identity Number U40109PB2010SGC033813 Website: www.pspcl.in

OFFICE OF THE CHIEF ENGINEER /GGSSTP,
(Dy.CE/Headquarter)

PROCUREMENT CELL-3, V&P.O. GHANAULI, ROOPNAGAR-140113
Phone no. 01881-275289 E-mail: Se-hq-ggsstp-ropar@pspcl.in

To

The Joint Secretary/ Computerization,
PSPCL, The Mall,
Patiala-147001
E-mail: tender@pspcl.in

Memo No-1843 /EMP-12812
Dated 13-9-24

Subject: Uploading of 1 No. press Tender on PSPCL's Website.

Enclosed please find herewith through E-mail the attachment of the following tender issued by this office for uploading the same on the PSPCL's web site immediately.

Sr. No	Tender Enquiry No & Dated	Estimated Cost (Rs)	Remarks
1	7616 /P-3/EMP-12812 dated 13.09.24	2.65 Lac.	NIT

DA/As above

Dy.CE/Headquarters,
GGSSTP, Roopnagar
13/9/24





Punjab State Power Corporation Limited

(Regd. Office :PSEB Head Office, The Mall Patiala – 147001,
Corporate Identity Number : U40109PB2010SGC033813 Website:www.pspcl.in

**OFFICE OF THE Chief Engineer/GGSSTP,
(Dy.CE/Headquarters)**

Procurement Cell-3, V&P.O. GHANAULI, ROOPNAGAR-140113

TENDER ENQUIRY No. 7616 /P-3/EMP-12812 dated: 13-09-24.

Procurement of Manholes for ID/FD/PA ducts.

1. DUE DATES & TIME :

- i Last date & time for Submission of :
Tenders in the office of DyCE/Headquarters ,Procurement cell
GSSTP Roopnagar upto 11.00 A.M. **27/9/24**
- ii Date & time for opening of Tenders : **29/9/24** at 11.30 A.M.

TELEPHONES / CONTACTS

2. i Dy.CE Headquarter **01881-275289**
- ii Email address : **Se-hq-ggsstp-ropar@pspcl.in**
ase.p3ggsstp@gmail.com

NOTE: -

1. In case the due date for opening of tender happens to be a holiday, then tenders would be received & opened on the next working day at the same time
2. The prospective bidders are requested to visit the website www.pspcl.in periodically even after downloading the specifications to check for corrigendum issued, if any. No corrigendum shall be published in newspaper.
3. Telegraphic / Fax/e-mail quotations shall not be accepted.
4. Negotiations shall not be held excepting with the lowest tenderer.



PUNJAB STATE POWER CORPORATION LIMITED

GURU GOBIND SINGH SUPER THERMAL PLANT ROOPNAGAR

NOTICE INVITING TENDER

Open Tender

Department Name	GGSSTP, Roopnagar.	
Tender Specification No.	7616 / P-3/EMP-12812 Dated : 13-09-24	
Tender Issuing Authority	Chief Engineer, GGSSTP, Roopnagar.	
Name & Complete Address of Office giving Tender	Chief Engineer /GGSSTP, Procurement Cell No.-1, VPO Ghanauli, Roopnagar – 140113 (Punjab) Phone No. 01881-275289	
Place	GGSSTP, Roopnagar- 140113 (Punjab)	
Short Description	Procurement of Manholes for ID/FD/PA ducts	Qty. as per Annexure -A
Tender Publication (Details of newspaper)	As per standard norms of Punjab State Power Corporation Limited, in English newspapers like Indian Express, Hindustan Times, The Tribune, National Herald & Times of India etc. Tender specification can only be downloaded from website www.pspcl.in	
Eligibility Criteria	As specified in NIT	
Last date and time for bid submission	27/9/24 Up to 11.00 A.M. in the O/o Dy CE/Headquarters / Procurement Cell / GGSSTP Roopnagar	
Bid Opening date (Part I & II)	29/9/24 at 11.30 AM in the O/o Dy CE/Headquarters / Procurement Cell / GGSSTP, Roopnagar	
EMD	Rs 5,310/- (Rs Five Thousand Three Hundred Ten Only)	
Contact phone no.	96461-55525	
Contact Email ID	Se-hq-ggsstp-ropar@pspcl.in ase.p3ggsstp@gmail.com	

Terms and Conditions

Fax/Telegraphic/e-mail tender shall not be accepted.

The tender shall be sent in two separate envelopes as under:-

Part-1- One envelope containing deposit of Earnest Money (if applicable)

Part-2- The other envelope containing the Technical /Commercial and price bid.

While opening the tenders, the envelope containing the Earnest Money (if applicable) shall be opened first and in case the deposit of Earnest Money is in accordance with the terms of the notice inviting tender only then second envelope containing the Technical /Commercial and price bid shall be opened.

b) The Firm
date of ex
This cl
has
23

- 3) The tender must be accompanied by **EARNEST MONEY** (If applicable as per Annexure-B). Bank details for refund of EMD (in case of unsuccessful bid) via RTGS mode must be provided by the bidder.
- 4) The rates should be quoted on **FOR destination basis** i.e GGSSTP Ropar giving break up of FOR Destination price for each item as per **Performa of pricing schedule** attached.
- 5) The Performa for price schedule enclosed with specification shall be filled by tenderers duly typed and **hand written prices shall not be accepted.**
- 6) In addition to the break-up of total price i.e. ex-works cost, GST, Freight, Insurance and Packing the bidders should also give split up of ex-works price.
- 7) **Split up of ex-works prices shall indicate cost of raw material, Labour component and overhead expenses.**
- 8) Raw material can further be divided into 3-4 parts depending upon type of material.
- 9) The offer should be kept valid for 120 days from date of opening of tenders.
- 10) The bidders are not allowed to indicate over all discounts on the quoted price for which split up has been given as mentioned in Sr. No. 6 & 7 above. However, quantity/payment discount can be given by the tenderer in the main tender.
- 11) Any firm offering discount on the quoted price or after the opening of tender will be out rightly rejected.
- 12) Competent authority may distribute the quantities to be procured on more than one firm.
- 13) All pages of quotation should be duly signed & stamped
- 14) Quantity can be increased or decreased.
- 15) Relevant literature/catalogue should be sent along with quotation.
- 16) **Negotiation shall not be held except with lowest bidder.**
- 17) Random testing of material on receipt in GGSSTP Store irrespective of the fact whether or not it was inspected before despatch shall be carried out by PSPCL. In case of any failure the entire lot shall be rejected at the risk and cost of the supplier.
- 18) Any deviation from PSPCL's standard terms and conditions be clearly mentioned in quotation under "**Schedule of deviations**" otherwise all terms and conditions will be deemed to have been accepted.
- 19) **Firm should mention GST number in their offer.**
- 20) The firm whose **manufacturing units** are situated in State of Punjab shall be granted order preference as per Clause no. 29 of Annexure-B to the extent of 50% of total value by de-escalating their rates by 15% in comparative statement on submission of undertaking enclosed.
- 21) **Tenders should enclose copies of Orders/Contracts against which they have supply same material to Thermal Plant of other states.**
- 22) Any firm which at the time of opening of the Tender enquiry, falls in any of the following categories, shall be regarded as defaulter and shall not be eligible for participation in any new Tender enquiry for a period of three years from the date of issue of Purchase Order in which it has defaulted:-
 - a) The Firm is a defaulter for the supply of 35% or more quantity on the date of expiry of the Contractual Delivery Period for the total ordered quantity.

b) The Firm is a defaulter for the supply of any quantity for more than 6 months from the date of expiry of the Contractual Delivery Period for the total ordered quantity. This clause shall be applicable item wise (all types, sizes and ratings) against which the firm has become defaulter under the above said conditions.

23) Payments can be made through RTGS system of Digital Payments instead of cheques to the suppliers/firms/contactors whosoever gives the consent. All the bank charges related to RTGS are to be borne by the suppliers/firms/contactors.

24) Firm which are registered with MSME are required to provide their registration certificate along with quotation. Please also note Clause no. 30(a) of Annexure-'B'

25) The firm should mention their complete address, official email ID & contact no. in the quotation.

26) **GST:**

a) The firm must have GST Registration number and same should be provided while quoting the rates. If the firm is registered under Composite Levies' then the same should be clearly mentioned in the quotation.

b) The firm must provide HSN Code for all items in price schedule Performa in Annexure' B'

c) Tax Rate as provided in quotation shall be final.

d) Any change in GST Rate after the submission of quotation and before the supply (with in delivery period) will be in PSPCL account. However no extra payment on account of increase in GST Rate after the delivery period of supply of material will be made.

e) Due to misclassification of HSN code, increase in tax will be in supplier account. However due to misclassification of HSN code, decrease in tax will be refunded to the PSPCL.

27. If any new firm submits its tender who has never supplied the tendered item to PSPCL till the date of opening of the tender enquiry, its works appraisal shall be carried out before opening of the Part-III i.e. 'Price Bid' to ascertain its financial/technical capability to execute the order. The cost of work appraisal shall be borne by the firm and the same shall be as under:- Rs. 50,000/- in case of firms with works located outside Punjab and Rs. 25000/- in case of firms with works located within Punjab for appraisal to be carried out.

28) All other terms and conditions are as per Annexure - 'B' attached.

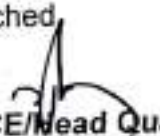
Dy.CE/Head Quarters,
GGSSTP, Roopnagar.

Annexure-B

GENERAL INSTRUCTIONS, TERMS AND CONDITIONS TO BE OBSERVED BY BIDDERS.

1. The following points shall be carefully studied /complied in order to ensure submission of a complete and comprehensive Tender. Quotations/bids not strictly in accordance with these instructions are liable to be rejected.:

- (i) The Tender must be complete in all respects.
- (ii) In case of manual Tendering:
 - a) Tender shall be submitted in duplicate and all copies shall be separately tagged and clearly marked as 'Original' & 'Duplicate'.
 - b) Quotations received by email/ fax will not be accepted except for proprietary items.
 - c) Tender shall be sent in three separate envelopes, one envelope containing Earnest Money and the second containing the main Tender in duplicate. While opening the Tenders the envelopes containing Earnest Money shall be opened first and in case it is found in accordance with the terms of Notice Inviting Tender only then the second envelope containing the Tender shall be opened.

2. The Officer inviting Tenders, Contracting/Purchasing Agency/PSPCL (herein after referred to as "purchaser") reserves the right to modify the schedule of requirements, technical particulars and the specifications at any time before the opening of the Tender enquiry and to place the order as a whole or in parts, and to reject any or all the Tenders received without assigning any reasons. He will not be responsible for expenses or losses that may have been incurred by the bidder in the preparation of it's Tender and nothing shall be paid on this account.

3. Quotations/Tenders should be enclosed in double cover both addressed to purchaser, i.e.

To

**The Chief Engineer/GGSSTP
Procurement Cell- 3**

V&P.O. Ghanauli, Rupnagar-140113 Phone 01881-275289

Both (inner & outer) covers shall be sealed and super scribed with Tender No. as given in Tender specification/ NIT along with the Tendered item and date of the opening of Tender enquiry.

4. Quotation/Tenderers shall be received in the office as mentioned at serial no. 3 above upto 11.00 A.M. on the due date given in the tender notice and shall be opened at 11.30 A.M. on the same day in the presence of tender or their authorized representative who may like to be present. In case the due date of opening tender happens to be a holiday, due date will be the next working day.

5. PRICES:-

(i) The unit rates shall be quoted F.O.R. destination. The nearest Railway stations are Rupnagar (Ropar), Ghanauli, Ropar Thermal Plant Railway Siding (for full wagon loads), Northern Railway. The break-up of the F.O.R. destination price shall be given as under :

(a) The price of the material inclusive of packing and forwarding charges forming part of production cost.

(b) Packing cost not forming part of production cost, handling charges, cartage, freight charges and transit risk insurance etc.

(ii) All taxes and duties leviable on the price of finished goods as per sub-clause (i) (a) shall be paid extra and the same should be shown separately as prevalent on the date of opening of the Tenders enquiry, to be paid at the rate as may be actually prevalent at the time of supply, otherwise these elements shall be deemed to be included in the quoted prices and will not be paid extra. No taxes and duties will be payable on the element of cost quoted under sub-clause (i)(b) except freight & insurance.

In case of Tenders processed manually, the Performa for price schedule shall be duly typed and prices written by hand shall not be accepted. The rates quoted whether FOR destination or ex-works should be given in both figures and words and any overwriting, erasing, cutting etc. should be avoided or if made, should be signed legibly.

(iii) In case of rates are quoted Ex-Works/Ex-Godown and for imported material, freight charges, transit risk insurance, handling and clearing charges, F.O.B. and C.I.F., Commission of clearing agents at Ports, should also be indicated in Part-III of Tender.

(iv) The quoted prices shall be 'FIRM'/'VARIABLE' as per the requirement. However, where variable prices are quoted, prescribed formula for price variations on the base price of component elements as applicable on the first day/first working day of the calendar month, one/ two/three months prior to the date of opening of the Tender enquiry, as per requirement of the item, shall form the basis for quoting variable rates. However, price adjustment shall be made on corresponding rates of variable elements prevailing on the first day/ first working day, of the month prior to (as prescribed in the Price Variation Formula) the date of readiness of material intimated in the offer by the firm for inspection or the date on which the offer for inspection of material is duly received in the concerned office (whichever is later), if the date of readiness of material is not specified in the offer. However, the period of two weeks for inspection as per Clause-23 of Schedule-B will not be counted for computing Price variation.

In case of delayed deliveries, the purchaser reserves the right to make payments for price variation on the basis of price computed according to the contractual delivery date or actual delivery date or date of offer whichever is advantageous to the purchaser.

Where-ever the prices of raw material are controlled by the Government, the basis shall be Government notification from time to time and in the remaining cases, notifications/ circulars issued by recognized associations like IEEMA, CACMA etc.

Note: Authority to decide the rates as FIRM or VARIABLE shall be the concerned Head of Department. Where the bidder does not specify the prices as FIRM or variable, the same shall be treated as FIRM.

6. Validity: -The offer should preferably be valid for 120 days from the date of opening of the Tender enquiry or as specified in NIT and any withdrawal or modification of the offer shall not be permitted.

7. Terms of Payment

(a) 95% payment of contract value pro-rata for each consignment of operationally complete equipment dispatched after approval of Inspecting Authority/Test Certificate etc. along with taxes & duties and Other Statutory levies as per contract shall be paid within 45 days (circular 15/2011) against receipted challans & submission of requisite documents. The balance 5% Payment shall be kept as performance Guarantee which shall be released after due receipt of Goods Receipt Note from the concerned consignee(s) or expiry of three months from the date of receipted challans & submission of requisite documents, whichever is earlier.

In case the due date of payment in terms of payment schedule falls on a holiday including Sunday or holiday is subsequently declared on that date, the payment shall be released on the first working day falling next to the due date.

(b) For delay in payments made by PSPCL beyond the stipulated period i.e. 45 days then simple interest @ 10% shall be given to the suppliers for delayed period subject to the condition that the delay in payment is more than seven days after the stipulated period i.e. 45 days. However, all-out efforts shall be made to prioritize the payment to all suppliers those come under MSMED Act-2006.

8. Delivery Schedule: -

The delivery of the material shall be completed within 2 months. The offer should clearly indicate monthly/bimonthly/quarterly schedule of deliveries, date of commencement and completion of supplies against items indicated in the Notice Inviting Tender/Specification which shall normally cover period for entire job of manufacture, testing, inspection and supply after acceptance of material after inspection and shall be reckoned from the date of dispatch in case of rail transport and Receipted Challan/Goods Receipt Note in case of road transportation by Goods Carriers. Purchase Orders shall be strictly placed on the above understanding. Ex-stock and earlier deliveries may be preferred, if required. However, The Purchaser reserves the right to defer the supplies of material, whenever deemed necessary. The necessary extension of Contractual Delivery Period for this period of deferment shall be granted to the firm on the same terms and conditions as contained in the Purchase Order-cum-contract agreement.

9. Penalty/Damages for delay in delivery :-

If the supplier fails to deliver the material/equipment within the stipulated delivery period of purchase order/contract, the same is liable to be rejected and if accepted, the supplier shall be liable to pay penalty @ ½% (half of one percent) of the cost of undelivered supply/incomplete equipment per week of delay or part thereof not exceeding maximum limit of 10% of the cost of complete unit of undelivered equipment/material so delayed. There will be no slack period.

10. Extension in Delivery Period: -

Any genuine delay in the approval of technical details, drawings, samples; issuance of amendment to Purchase Order; carrying out inspection; approval of Test Reports/Test Certificates issuance of dispatch instructions/ stations etc. will count towards extension of the delivery period by corresponding period other than that admissible under Force Majeure conditions, if any substantiated by the suppliers, and duly accepted by the Purchaser. No extension in delivery shall be granted in case of delay in payment.

11. Negligence, Default: -

In case of any negligence on the part of a Supplier/Contractor to execute the Purchase-order /Contract with due diligence and expedition and to comply with any reasonable orders, pertaining to any contravention to the provisions of the Purchase-order/Contract, given in writing by the purchaser, the purchaser may give a 21 days-notice in writing to the Supplier/Contractor to make good the failure/neglect /contravention. In the event the Supplier/Contractor fails to comply with the notice within a timeframe considered to be reasonable by the purchaser, the business dealings shall be suspended / terminated with the firm by the purchaser for a minimum period of three years or in extreme cases, the firm shall be blacklisted forever by the purchaser.

Apart from the suspension/termination of business dealings/blacklisting of the supplier/contractor, the purchaser shall also forfeit the security & other pending payments of the Purchase Order/ Contract against which the supplier has defaulted, in addition to PEMD/ EMD lying with the concerned organization.

Recoveries of any dues relating to Purchase Order under which supplier/contractor has defaulted shall be made from pending amount of any Purchase order/Work Order/Contract of the firm or any Security/EMD or PMED lying with PSPCL.

12. Force Majeure: -

During the pendency of the Contract/Purchase Order, if the performance in whole/part by either party or any obligation there under, is prevented/delayed by causes arising out of any natural calamity, war, hostilities, civil commotion, acts of the public enemy, sabotage, fire, floods, explosion, epidemics or non-availability of Government controlled raw material under orders/ instruction of Central/State Government regulations strikes, lock-outs, embargo, acts of Civil/Military authorities or any other causes beyond their reasonable control, neither of two parties shall be made liable for loss or damages due to delay or failure to perform the contract during the currency of Force Majeure conditions, provided that the happening is notified in writing (with documentary proof) within 30 days from the date of the occurrence.

The supplies shall be resumed under the contract as soon as practicable after the happening (event) ceases to exist.

13. EARNEST MONEY DEPOSIT (EMD)

i) In case of open and Limited Tenders, the Tenderer shall be required to submit Earnest Money at the following rates in the form of Punjab State Power Corporation Ltd. cash receipt/Demand Draft payable at Ropar in favour of Accounts Officer, GGSSTP, Rupnagar-140113 or E-payment along with the Tenders:-

a) Tender valuing less than Rs. 5,00,000.00 and Spot tenders	Nil.
b) Tender valuing Rs 5,00,000.00 & above (Other than spot tender)	@2% of Tender value rounded off to a multiple of Rs. 10/- on the higher side, subject to minimum of Rs. 10,000.00 and maximum of Rs. 20 lac.

ii) The following shall be exempted from depositing the Earnest Money:-

(a) Public Sector Undertakings owned by Pb. Govt./Central Govt./Other State Govts. supplying material directly through units owned by them subject to submission of documentary evidence of Government ownership. Exemption shall not be applicable if the Tender is submitted for supply of material through private unit/manufacturer.

(b) Suppliers having Permanent Earnest Money Deposit of Rs.25 lac with the PSPCL provided that a certificate to this effect issued by the Nodal Authority i.e. AO/CPC(MM) of PSPCL, during six months immediately preceding the due date for Tender opening and showing the Serial. No./Account No. allotted in the Permanent Earnest Money Deposit Register shall be submitted by the Tenderers in the envelope for Earnest Money.

(c) Suppliers of Proprietary items/ firms supplying items under DGS & D rate contract.

(iii)

(a) In case of Tenders not accompanied by full amount of Earnest Money for the items Tendered but not less than 25% of the amount due, the order/contract shall be awarded only for part of material/equipment/service limited to a value corresponding to the actual amount of Earnest Money. submitted with the Tender provided the placing of such part order is otherwise feasible and is in the interest of the PSPCL, otherwise such Tenders shall be ignored.

(b) The amount due, as referred to in clause 13(iii) (a) shall be calculated @ 2% of the Tender value and shall not be taken as 20,00,000/-i.e. the maximum amount payable as Earnest Money. Therefore 25% of earnest money shall thus be worked out on the basis of the entire amount so calculated, which shall, of course, be subject to maximum of Rs. 20,00,000/- and minimum of Rs. 10000/-.

(iv) In order to dispel any doubt, the correct amount payable of earnest money, in cases covered in clause-13 (iii)(a) shall be worked out as per illustration given here under:-

Sr. No	Tender Value (say)	EMD @ 2% of Tender value (Rs)	EMD @ 25% of Col.(3)	Correct Amt.of 25% EMD to be deposited for qualifying to get 25%	Correct Amount full EMD to be deposited	Remarks
1	Less than 5 Lacs	Nil	Nil	Nil	Nil	EMD exempted below 5Lacs
2	5 lac	10,000	2500	10,000	10,000	Min. EMD as per clause 13(i)(b)
3	10 lac	20,000	5,000	10,000	20,000	
4	25 lac	50,000	12,500	12,500	50,000	
5	50 lac	1,00,000	25,000	25,000	1,00,000	
6	1 crore	2,00,000	50,000	50,000	2,00,000	
7	5 crore	10,00,000	2,50,000	2,50,000	10,00,000	
8	6 crore	12,00,000	3,00,000	3,00,000	12,00,000	
9	10 crore	20,00,000	5,00,000	5,00,000	20,00,000	
10	25 crore	50,00,000	12,50,000	12,50,000	20,00,000	Max. EMD as per

						clause 13(i) (b)
--	--	--	--	--	--	---------------------

(v) Earnest Money shall be forfeited in case of withdrawal/modification of an offer within the validity period, as required in the NIT/Tender Specification after opening of Tender.

(vi) In case of successful Tenders, Earnest Money shall be converted Security Deposit and shortfall, if any shall be got deposited for faithful execution of Purchase Order/Contract.

(vii) In case of Tenders not accepted, the Earnest Money shall be refunded within 30 days of the award of order/contract of the successful Tenders.

In case of firms not falling within the zone of consideration earnest money may be refunded immediately wherever possible.

14. SECURITY DEPOSIT.

(i) The successful Tenderers shall be required to submit Security deposit for faithful execution of the purchase order/Contract of value exceeding Rs. 1,00,000/- at the rate of three percent (3%) of ordered value rounded off to a multiple of Rs. 10/- on the higher side. Tenderers exempted from EMD upto Rs. 5.0 Lacs will have to submit security deposit for Purchase Orders valued above 1.0 Lacs.

(ii) Ordinarily the Earnest Money received against Tenders shall be converted into Security Deposit. If the amount of earnest money received against Tenders is more than the amount of Security Deposit required against the Purchase Order/Contract, the balance shall be refunded within one month of the finalization of the Tender enquiry and in case of shortfall, if any, the Contractor/Supplier shall be required to deposit the additional amount.

(iii) The Tenders having Permanent Earnest Money Deposit (PEMD) of Rs. 25 lacs (Rs. Twenty Five Lacs) with PSPCL and hence exempted from depositing Earnest Money with Tenders, shall also be required to submit security Deposit @3% of ordered value in the form of Bank Guarantee/ Demand Draft/ Cash within 30 days from the award of purchase order/contract.

(iv) The following shall be exempted from depositing security against purchase orders/contracts given to them :-

a) Public Sector undertakings owned by Pb. Govt./Central Govt./other State Govt. supplying material directly through units owned by them subject to submission of documentary evidence of Government ownership. Exemption shall not be applicable if the Tender is submitted for supply of material through private unit/manufacturer.

(v) On faithful execution of Purchase Order/Contracts in all respects, including warranty period, if any, Security Deposit of the Contractor/Supplier shall be released by the Contracting/Purchasing Agency. The refund shall be made within 30(thirty) days from the issue of security release order by the concerned purchasing agency.

(vi) In the event of default on the part of the Contractor/Supplier in the faithful execution of Purchase Order/Contract his Security deposit shall be forfeited by an order of the Contracting/Purchasing Agency under intimation to o/o CE/IT who shall get the same uploaded & displayed on website of PSPCL.

The forfeiture of Security Deposit shall be without prejudice to any other rights arising or accruing to the Board under relevant provisions of the purchase

Order/Contract like penalty etc. including suspension of business dealings with PSPCL for a specific period.

15. INTIMATION TO CHIEF ACCOUNTS OFFICER/DY. CHIEF ACCOUNTS OFFICER & CONSIGNEES.

The Suppliers will intimate in advance the probable date of dispatch through fax/ email regarding the actual date of R.R. to the Financial Advisor-cum-Chief Accounts Officer/ Chief Accounts Officer/Deputy Chief Accounts Officer to enable him to arrange payment, failing which demurrage, wharfage etc. will be to Supplier's account. A copy of such intimation shall also be immediately sent to the consignees and concerned Chief Engineer for reference, immediately.

16. GOODS AND SERVICE TAX:- PSPCL is registered centrally in the state under GSTIN 03AAFCP5120Q1ZC.

- GST, as applicable, will be paid as per prevailing provisions of GST Act & Laws against submission of documentary proof at rate(s) prevailing during the contracted delivery period on the basis of actual. The following certificates shall have to be furnished along with invoice –cum- gate pass duly signed by the authorized agent /signatory. The first invoice should accompany the specimen signatures of the authorized signatory duly attested by the Managing Director of the factory with a copy of orders regarding his appointment as authorized signatory.

- Certified that the transaction on which the GST is claimed has been/shall be included in the return submitted / to be submitted to the GST Authorities and the amount claimed from the Punjab State Power Corporation Ltd. has been / shall be paid to the GST Authorities.

- Certified that the goods on which GST has been charged have not been exempted under GST Act or rule made there under and that the GST charged on these goods is not more than what is payable under the provisions of relevant act.

- Certified that we shall indemnify the Punjab State Power Corporation Ltd. in case, it is found, at a later stage that wrong or incorrect payment had been received on account of GST; the same will be refunded.

- Certified that we are registered dealer under the GST Act and our Registration No. is _____

- In case the GST is applicable and is required to be paid extra as referred to Para-(i) above, the tenderer should clearly indicate HSN code of item along with present rate (in percentage) applicable to their company.

iii) The maximum rate (in percentage) up-to which the GST may become leviable/ payable under the prevailing Rules & Regulations applicable to their company, should also be clearly indicated in their tender.

iv) In case the GST is applicable /payable, necessary certificate of GST claimed / GST Gate Pass duly authenticated by the authorized representative of GST Authorities, shall however, be furnished by the supplier along with each consignment. The supplier should, therefore, clearly indicate in their tender that whether such GST Gate Passes/Certificates shall be furnished by them or not.

NOTE: The firms indicating nil or concessional rate of GST in their tenders (if any) will have to absorb GST up to the full rate applicable at the time of tendering.

v) FURTHER any loss due to non-availability of ITC or levy of penalty/ interest payable by PSPCL on account of non-filing of return or non-compliance or any miss-statement given under the provisions of GST ACT by the firms shall be recoverable from them.

vi) Further GST at applicable rates on principal supply shall be payable on Freight and Insurance.

17. INSURANCE

i) The rates are required to be quoted F.O.R. destination and it is the responsibility of the Supplier to deliver the material FOR Destination in good condition. Supplier at his option may insure the material against all risks during transit at his own cost for full delivered value of the material upto destination. All works in connection with making and settling of claim, with Railway Authorities and/or Insurance Company, if any, shall be carried out by the Supplier for which no extra payment shall be made by PSPCL. However, necessary assistance required in connection with making and setting such claims, if any, shall be provided by the consignees.

ii) All damages and/or shortages during transit as covered by the Insurance, shall be made good by the supplier immediately on receipt of such information from the consignees without, waiting for settlement of claims. However, in case of apparent damages and/or shortages, the consignees shall obtain the loss/damage certificate from the Concerned Authorities and send the same to the Contractor within a period of thirty days from the date of receipt of material. A certificate shall be submitted by the Suppliers/Contractors with each bill to the effect that the material has been duly insured.

iii) The consignees shall report losses damages to the supplier within 30 days of the arrival of the equipment. It will, however be the responsibility of the supplier to timely lodge claims on the insurance under writers and to arrange replacement there of.

iv) The suppliers shall be wholly responsible for the loss, shortages, damages etc. during transit. Such short supplied, damaged material etc. will have to be replaced/repared by the Supplier/Contractor free of cost immediately without waiting for maturing of the Supplier's/Contractor's Claims with the Road Transport/Railway Authorities regarding insurance.

v) In case replacement/repair of defective material is not carried out within six months of intimation of damages, supplier shall have to pay interest @12% per annum on the payments made by PSPCL, if any, from the date of its payment upto the date of the re-commissioning of the equipment after replacement/repair or to the date the default is made good.

18. WARRANTY

"The supplier/Contractor shall be responsible to replace free of cost with no transportation and insurance expenses to the purchaser up to the destination of material/equipment, the whole or any part of the material, which under normal and proper use and maintenance, proves defective in material or workmanship within 12 months from the date it is taken over by the purchaser or 18 months from the date of dispatch in respect of indigenous equipment or 24 months from the date of shipment for imported material, whichever expires earlier. Provided the Purchaser gives prompt written notice of such defects to the Supplier/Contractor. Such replacement shall be affected by the Supplier/Contractor, within a reasonable time not exceeding 6 months of the intimation of defects. Suppliers/Contractor's responsibility arising out of supply of material or its use whether on warranties or otherwise, shall not in any case exceed the cost of correcting the defects or

replacing the defective part/material and upon the expiry of the warranty period stipulated above, all such liabilities shall terminate.

The above provision shall equally apply to the material so replaced/repared by the supplier/ contractor under this clause, in case the same is again found to be defective within 12 months of its replacement/ repair.

In case the replacement/repair of defective material is not carried out within six months of intimation of defects, the supplier/Contractor shall have to pay interest @ 12% per annum on the value of each complete operational unit of equipment beginning from the date its becoming defective upto date of its re-commissioning after the replacement/repair. Purchasing Authority, however, for items other than transformers, meters, LT Switches fuse units, L.As, L.T. capacitors and project equipment may reduce warranty period for six months, for items the identification of which after installation is not feasible."

19. CHANGES

No variation or modification or waiver of any of the terms and provisions shall be deemed valid unless mutually agreed upon in writing by both the Purchaser and the Supplier.

20. DISPATCH INSTRUCTIONS

The material will be required to be dispatched as per the dispatch instructions issued by the PSPCL. However, efforts shall be made to rationally consign the material on truck load basis to as minimum number of stores as possible.

21. RAW MATERIAL

The raw material to be used in the manufacture of the goods/equipment to be supplied against Purchase Order/Contract shall be new and of the best quality of its kind available in the market. The Supplier/Contractor shall be solely responsible for the procurement of raw material required for the purpose.

22. SAMPLES

Whenever asked for, samples must be supplied by the Contractors/Suppliers free of cost. Ordinarily samples will not be returned to the Tenderer/Supplier. However, if desired by the Supplier/Contractor and feasible for the purchaser, the sample shall be returned to him at his own risk and cost.

23. INSPECTION AND TEST

a) PSPCL shall inspect, examine and test the equipment/material through its official (s) and/or through an outside agency nominated by the PSPCL at the manufacturer's/ supplier's work, during or after the manufacture of goods prior to dispatch, on receipt of clear notice of minimum two weeks in advance, to be reckoned from the date of receipt by the purchaser. The supplier/Contractor shall provide all facilities as may be required to carry out the test in accordance with approved standards free of cost.

b) The concerned Head of Department shall get the stage inspection of Transformers carried out at supplier's works.

c) On receipt of material in the stores/workshops, PSPCL shall inspect the material at random as per provision of the Purchase order/contract irrespective of the fact whether or not, it has been inspected before dispatch. If the shortage/deviation from declared quantity /specification is noticed, the same shall be reported immediately by the consignee to the supplier, under intimation to all concerned. On receipt of such intimation from consignee(s), the CE in charge of the

stores/workshops shall fix a date and time for joint verification under intimation to the supplier & all concerned giving minimum 10 days-time. The checking shall be carried out in the presence of firm's representative at Destination Station and in case the firm's representative does not happen to be present at destination on the specified date & time so fixed, then PSPCL shall be at liberty to do joint verification in his absence. The shortage/discrepancies so detected shall be applied on the full lot. In case shortage /discrepancies, in particular lot supplied to various consignees, are also noticed by different consignees, the above procedure shall be followed for joint verification by each and all such consignees. The maximum shortages/discrepancies detected by any of the consignees shall be applied to the entire lot of material supplied to various consignees.

In case of any failure of material during random checking, PSPCL reserves the right to reject the entire lot at the risk and cost of the supplier. In case of repeated shortages/discrepancies the firm shall be liable for suspension of business dealings/black listing. This is without prejudice to the other rights arising/accruing to the purchaser under various clauses of the Tender specification & Purchase Order-Cum-Contract.

24. TEST CERTIFICATE AND INSTRUCTION BOOK

The Supplier/Contractor shall be required to furnish to the Purchaser/consignees, wherever necessary, the following documents along with consignment :-

- (i) Printing Pamphlets/ Catalogues Copies
- (ii) Instruction Book Copies
- (iii) Drawings Copies
- (iv) Any other relevant information (to be incorporated at the time of placing the purchase Order)

In case, the goods have not been inspected/tested at the manufacturer's works by a representative of PSPCL, the Supplier/Contractor shall furnish the following certificates to purchaser/ consignee along with consignment.

- a) Type test certificate/ Acceptance Test Certificates
- b) Routine test certificate.

25. FAKE INSPECTION CALLS

The purchasing authority will get the material inspected and issue dispatch instructions within 20 days of the date of receipt of call offering the material for inspection or date of readiness of material, whichever is later. In case date of readiness is not mentioned in the offer letter, then date of receipt of call shall be considered as date of readiness of material. In case the inspecting officer finds on arrival at the supplier's premises that the material less than 80% of the quantity offered in the inspection call is ready for inspection or material of the firm is rejected during testing/inspection, then the call shall be treated as fake call and the firm shall be responsible to pay fake call charges @ 10% of the value of the offered lot calculated as per P.O. rate subject to a maximum of Rs. 30,000/- per such occasion. Besides this, a letter of warning shall be issued and it shall be counted towards their performance for all intents and purposes. In case multiple sizes are to be inspected against a single inspection requisition, then the fake call charges shall be applicable on proportionate basis based on the PO value of items which were offered by the firm for inspection.

26. CANCELLATION OF PURCHASE ORDER

The purchaser reserves the right to cancel the purchase order/ contract as a whole or in part at any time without any financial liability on either side prior to the receipt of intimation regarding taking in hand the manufacture of material.

During the pendency of the Purchase order/ contract, if lower rates are received against the subsequent Tender Enquiry/Enquiries, then the supplier, whose overall contractual delivery period has expired, shall be offered to supply the material at either of the following rates, whichever is lower, along with any other terms and conditions at variance from the conditions as contained in the original purchase order, if any:

- a) Rates payable as per the terms and conditions of the Purchase Order less penalty as applicable
- b) Rates received against subsequent Tender Enquiry/Enquiries

In case the supplier refuses to accept the offer, then the purchase order shall be cancelled without any financial liability on PSPCL. However, if the supplier is debarred as per Regulation 10 (x), then the cancellation of purchase order shall not have any effect on the debarred status of the supplier.

27. JURISDICTION

All legal proceedings in connection with the Purchase Order/Contract shall be subject to the territorial Jurisdiction of the local Civil Courts at Ropar (Punjab).

28. ARBITRATION

a) If at any time any question, dispute or difference, whatsoever, shall arise, between the Purchaser/PSPCL and the Contractors/Suppliers, upon or in relation, to or in connection with the Purchase Order/Contract, either party may forthwith give to the other, notice in writing of the existence of such question dispute or difference and the same shall be referred for sole arbitration as per the provisions of the Indian Arbitration Act, 1996 (amended upto date) who shall give a reasoned/speaking awards. The award of the Sole Arbitrator shall be final and binding on the parties under the provisions of the Indian Arbitration Act, 1996 (amended upto date) and of the rules there-under. Any statutory amendment, modification or re-enactment thereof for the time being inforce, shall be deemed to apply to and be incorporated in the Contract/Purchase Order.

b) Upon every or any such reference, the cost and incidental expenses to the reference and award shall be at the discretion of the Sole Arbitrator so appointed who may determine the amount thereof or direct the same to be taxed as between Solicitor and Client or as between party and party shall direct by whom and to whom and in what manner the same is to be borne and paid.

c) The work under the Contract shall, if reasonably possible, be continued during the proceedings of the arbitration and no payment due/ payable to the firm by the Purchaser/PSPCL shall be with-held on account of such proceedings.

29. ORDER PREFERENCE

PSPCL shall allow an order preference as per the procedure laid down as under to such bidders whose works are situated within the State of Punjab:-

a) The rate of Punjab based firms shall be de-escalated by 15% for all the units (i.e. 100* Quoted Rates/115). For these firms quantity up to 50% of the total ordered quantity may be reserved provided their de-escalated rates fall below the lowest rates considered for the placement of purchase orders/ contract. For the purpose of allocation of quantity against Order Preference, the merit position of the Punjab based eligible firms shall be prepared separately. However, where the Punjab based firms qualify amongst the lowest bidders on their own quoted rates, they shall also form part of the original merit list without order preference for the purpose of allocation of quantity.

U. FOR
b) Purchase order on the Punjab firm claiming order preference & found eligible as per clause (a) above would be placed on the lowest rates (L-1) considered for the placement of purchase orders/ contract

c) The Punjab based firms claiming order preference shall be required to furnish an undertaking in prescribed form (Annexure-II) on a non-judicial stamp papers of appropriate value duly notarized to the effect that they shall execute the order if placed on them under 'Order Preference' as per the Tender specification. Such undertaking shall be submitted by the Punjab based firms latest by 5:00 PM on the day of opening of price bid and duly acknowledged by the concerned office.

d) In case no such undertaking is furnished by the Punjab based firms, who are otherwise eligible for claiming 'Order Preference' as per the Tender specification, their Tender shall not be considered for placement of any order under Order Preference. In the event of refusal by the Punjab based firms to execute the purchase order/contract at their quoted rates or offers made under Order Preference as per 'a' and 'b' above as the case may be after furnishing the above undertaking as per Annexure II their earnest money shall be forfeited apart from initiating further administrative action, such as suspending business dealings blacklisting etc.

30. CONSTITUTION, EXPERIENCE AND FINANCIAL STANDING

The Tenderers shall invariably supply the following information with the Tenders :

a) Constitution and Composition of the firms

(i) If a Joint Stock Company, copy of its Memorandum and articles of Association and other particulars.

(ii) If a partnership firm, a copy of the partnership deed and particulars of its partners.

(iii) If a proprietary concern, the standing of the proprietor and if registered with the Registrar of Companies/Firms, their registration No etc.

(iv) Documentary evidence (Latest copy of memorandum of Micro Small & Medium Enterprises filed under section-8 of MSMED Act, 2006 duly acknowledged by competent authority.) of being a Micro, Small & Medium Enterprise. If the bidder does not submit the proof at the time of submission of its bid, it shall be considered as a Large Enterprise.

(v) A certificate for the last financial year, duly signed by any Director/Partner/Proprietor and Chartered Accountant that investment in Plant & Machinery of the enterprise does not exceed Rs. 25 Lac in case of micro and Rs. 5.00 Cr in case of small enterprise as prescribed in section 7 (1) a (i) & (ii) of the MSMED Act, 2006.

b) In case of authorized representative.

i. Name and particulars of manufacturers

ii. Certified copy of the instrument of authorization of the Supplier/Manufacturers.

iii. Experience and standing in the market.

c) Particulars of the Purchase order/ Contracts executed with PSPCL and/or performance certificates of having executed Purchase Order/Contract of other State/ Central utilities.

d) Financial Position

(i) Balance sheets etc. for the last three years, including Trading, manufacturing, Profit and Loss Account should be duly certified by the Chartered Accountant.

(ii) Copy of PAN Card of the firm and director(s) and IT returns of last 3 years.

(iii) Bank references.

(iv) Solvency certificate not more than 12 months old.

31. INFORMATION REGARDING LIST OF BANKERS, THE PURCHASER DEALS WITH

a) The Railway receipt/Goods Receipt and invoice etc. to be sent to the authorities as specified in the Purchase Order.

b) Any demurrage occurring as a result of sending Railway Receipts/Goods Receipts through a Bank as specified in the Purchase order/ contract will be to the account of the Supplier/Contractor.

c) No goods will be accepted by the consignees unless accompanied by challan /invoices containing the prices/quantity etc.

32. The Firm should give the following undertaking with their offer, otherwise their tender is liable to be rejected.

"We shall not pay any commission etc. or engage any Commission Agent or Liaison Agent for dealing with the PSPCL in any matter including Purchaser of equipment/Spares etc.

33. Rejection of Tenders:

The following types of tenders shall be rejected.

(i) Tenders from firms/contractors who are blacklisted or with whom business dealings are suspended.

(ii) Tenders submitted by firms who did not purchase a set of tender documents/specifications as required.

(iii) Tenders submitted by a person directly or indirectly connected with service, under the Government, Board or Local Authority. Tenders not accompanied by the required amount of Earnest Money as per Clause -13

(iv) Tenders received late.

34. Supply to Thermal Plants:

Tenders should enclose copies of Orders/Contracts against which they have supply similar material to 110MW or larger Unit Thermal Plant.

35. Important Notes:

(i) Make of each item/Manufacturer's details should be given for each item. Mention if ISI/PQ marked or as per ISS.

(ii) Rates should be quoted F.O.R. destination only.

(iii) The goods should be packed suitably at Contractor's/Supplier's own responsibility.

36. Tender is liable to be rejected if any of the above terms are not complied with.

13/9/24
Dy.CE/Head Quarters
GGSSTP,Rupnagar

ANNEXURE-A
ENQUIRY NO. 7616 /P-3/EMP-12812 DATED
DETAIL OF MATERIAL AND TECHNICAL SPECIFICATIONS

Sr. No.	GGSTP Code No.	Description of Material	Unit	Qty.
1	08080180	Manholes for ID/FD/PA Ducts as per drawing at Annexure-1	Nos	30

Note:

- a) The rates of GST for each item should be indicated separately in the offer.
- b) The Firms should supply their GST Registration certificate along with offer/quotation.

Dy.CE/Headquarter
GGSTP, Roopnagar

Annexure-D
Performa of pricing schedule

*BREAK UP OF F.O.R. DESTINATION PER UNIT PRICE FOR EACH ITEM
(THIS MUST ACCOMPANY THE TENDER DULY TYPED)*

NAME OF TENDERER : _____
QUOTED QUANTITY : _____
NATURE OF PRICE : **FIRM**

A)	Break-up	(Rs.)
1.	Ex-works per unit price inclusive of packing forwarding (forming part of production) a) Cost of Major Component per item b) Cost of Minor Component per item. c) Cost of Labour charges per item. d) Overhead expenses per item. e) Packing charges forming part of production cost f) Any other charges	
2.	GST @ _____ %	
3.	Sub total (1+2)	
4.	Packing cost (not forming part of production cost)	
5.	GST @ _____ %	
6.	Sub total (4+5)	
7.	Forwarding charges.	
8.	GST @ _____ %	
9.	Sub total (7+8)	
10.	Freight charges.	
11.	GST @ _____ %	
12.	Sub total (10+11)	
13.	Insurance charges	
14.	GST @ _____ %	
15.	Sub total (13+14)	
16.	Total (6+9+12+15)	
17.	All-inclusive FOR Destination per unit Rate (3+16)	

Note: 1. The firms should quote FIRM Prices only and offers of firms quoting variable prices shall be out rightly rejected

Name: _____
Designation: _____
Address and Seal of the firm

NOTES:

- i) If rate of GST in Para A is not given, the maximum applicable rate of GST, prevailing at the time of opening of tender, shall be taken into consideration.
- ii) The firms indicating NIL or concessional rate of GST in their tenders will have to absorb GST up to the full rate applicable at the time of tendering. The firm who do not agree to this stipulation or indicate GST as *extra without indicating* the applicable rate shall be loaded with maximum rate of GST for evaluation purpose.
- iii) In case quoted prices or any other declaration/ statement given in this annexure do not tally with the ones given in main tender or elsewhere, the ones given here shall be considered as the quoted price.
- iv) Any arithmetical error shall be considered to the advantage of the purchaser.
- v) The bidders shall not be allowed to indicate over all discount on the quoted price for which split up has been given. Any firm offering discount of the quoted price or after the opening of tender will be out rightly rejected.
- vi) The provisions of GST acts shall prevail upon wherever applicable in the terms and conditions of the specification.
- vii) The firm shall indicate the HSN code of each item.
- viii) Tender's evaluation shall be done item wise.

ANNEXURE-C

SCHEDULE OF DEVIATIONS (To be filled by tenderer)

Tenderer shall carefully state below any and all points in this proposal which are not in accordance with PSPCL's Technical Specification and the General Instructions:-

Sr. No.	Para no.	Technical Deviation, if any.
1. 2. 3. contd...		
Sr. No.	Para no.	General Deviation, if any.
1. 2. 3. contd...		

We hereby certify that the abovementioned are the only deviations from Purchaser's saforesaid specifications and general conditions.

Dated.

Authorized Signatory

Name: _____

Designation: _____

Address and Seal of the firm

Note: The tenderer is to clearly indicate any deviation in technical & general terms and conditions in this Annexure only. In case, the Technical Specification as well as General conditions of Tender Specifications are acceptable in toto, the word 'NIL' shall invariably be put in the above Columns. In case, nothing is mentioned here then it shall be presumed that there is no deviation in the offer and terms and conditions of the specifications are acceptable to the bidder in toto.

ANNEXURE-H
UNDERTAKING FORM

(To be entered on a Non-Judicial Stamp Paper of Rs. 50/- only)

We _____ state that our works are situated in the State of Punjab and we claim "Order Preference" as stipulated in the PSPCL tender specification No. _____ due on _____ against which we have submitted our tender No. _____ dated _____. We under take to execute the order/contract if placed/awarded on to us even by counter offer at the rates worked out by Punjab State Power Corporation Limited in accordance with its Purchase Regulations. It is further understood that in the event of refusal by us or failure on part to execute the order/contract (full or part) placed/awarded on to us under "Order Preference" on any account what-so-ever, the Punjab State Power Corporation Limited shall have the right to forfeit the earnest money deposited by us and we shall have no claim for the refund thereof. The Punjab State Power Corporation Limited shall also have the right to suspend business dealing with us and to black-list our firm, without prejudice to other rights accruing to the Punjab State Power Corporation Limited under the Purchase Order/contract, if placed/awarded on to us.

Signature of Constituted Attorney

ANNEXURE-I

UNDERTAKING FORM NON PAYMENT OF COMMISSION ETC

We will not pay commission etc. Or engage any commission agent or liaison agent for dealing with the PSPCL in any matter including purchase of specifications etc.

DATED :

SIGNATURE OF BIDDER
NAME
DESIGNATION
SEAL OF FIRM/COMPANY

ANNEXURE-G

GENERAL COMMERCIAL PARTICULARS
(Following information must be supplied by the tenderers)

1.	Quantity quoted	Nos.		
	GST			
	i) Rate considered in quoted prices	@		
	ii) GST No of firm			
	iii) In case Nil / Concessional rate of GST is applicable then maximum rate of GST applicable at the time of tendering will be absorbed by us.	YES		
2.	Validity of offer	120 days from the date of opening of tender enquiry		
3.	Schedule of delivery	Two Months (02 Months)		
4.	Terms of Payment	As per PSPCL specification		
5.	Nature of Price	FIRM		
6.	Turnover (Rs. in Cr.)	19-20	20-21	22-23
7.	1) PAN of Firm			
	2) PANs of all Directors/ Partners			
	3) IT returns of Last three years (To be attached)			
8.	Documentary evidence regarding MSME States			
9.	Composition & constitution of Firms			
	1) Joint stock company			
	2) Partnership firm			
	3) Documentary evidence regarding MSME States			
	4) Proprietary firm			
10.	Balance sheet (last 3years)			
11.	Bank reference			
12.	Solvency certificate not more than 12months old			
13.	a) Name/ Designation of Contact person			
	b) Mobile No			
	c) Email id			
14.	Any other information to be mentioned by the bidders			

Dated.

Authorized Signatory

Name: _____

Designation: _____

Address and Seal of the firm

ANNEXURE-E

PROOF OF ABILITY / EXPERIENCE

The tenderer shall submit copies of POs of supplies of similar material, along with proof of satisfactory execution of supplies, such as Performance/ Completion certificates etc. made by them to other State Elec. Boards/ State Govt./ Govt. of India & their Institutions/ Undertakings on the Performa given below:-

Sr. No.	Material	PO No. & dt. Ordered quantity	Quantity supplied	Purchaser's Name & address	Name/Designation Address & Phone No. of the purchasing agency	Remarks
1						
2						
3						
4						
5						
6						
7						
8						
9						
10						

Note: Copies of performance/ execution certificates or any other supporting documents having supplied the material to any other State Elec. Board/ State Govt./ Govt. of India/ State Power Utilities should be enclosed with the tenders. Only copies/ list of POs may not be treated as authentic proofs.

Answer -1

Manhole for Ducts

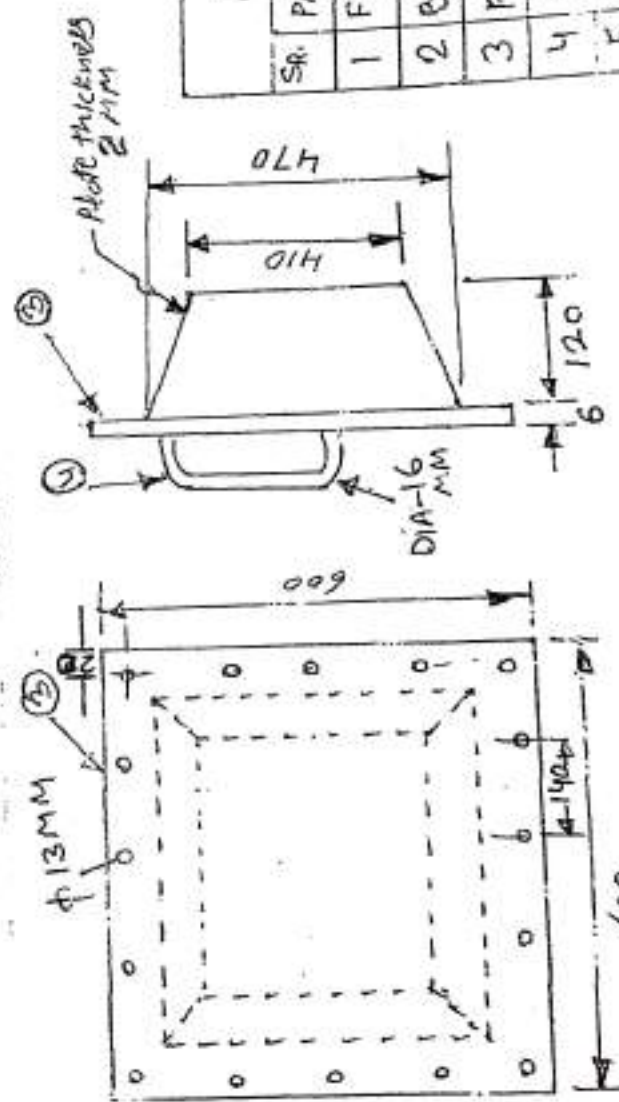
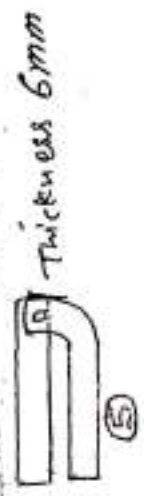
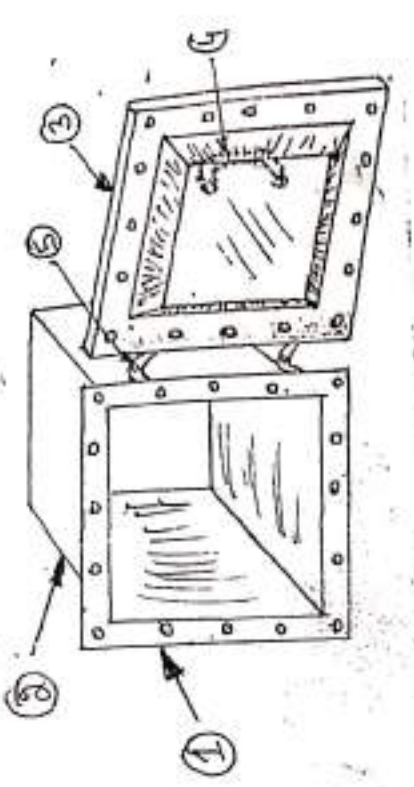
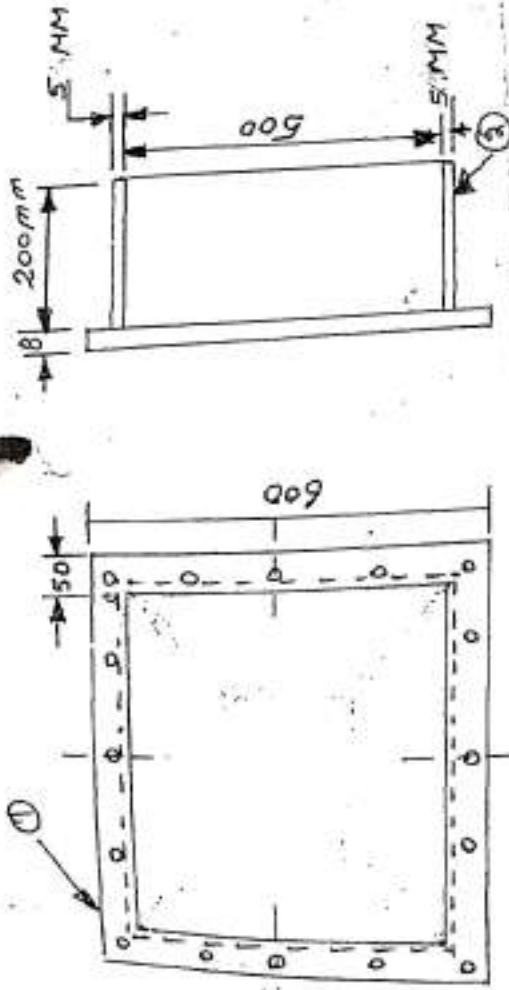

MAN HOLE FOR HOT AIR DUCT

Sr.	PART NAME	MATERIAL GRADE	QTY
1	FLANGE PLATE	IS-2062 PLATE	1
2	BACK PLATE	IS-2062 PLATE	4
3	FRONT DOOR	IS-2062 PLATE	1
4	HANDLE	IS-2062 (ROUND)	1
5	HINGE	IS-2062 PLATE	2
6	HEX HD Nut & Bolt	MS	16 No

NOTE - All dimensions are in mm.